

---

# Installation and User Guide

---

**PIKE**  
TECHNOLOGIES  
*Spectroscopic Creativity*



---

## 13mm Die Kit

KBr Die and Anvils

---

The information in this publication is provided for reference only. All information contained in this publication is believed to be correct and complete. PIKE Technologies, Inc. shall not be liable for errors contained herein nor for incidental or consequential damages in connection with the furnishing, performance, or use of this material. All product specifications, as well as the information contained in this publication, are subject to change without further notice.

This publication may contain or reference information and products protected by copyrights or patents and does not convey any license under the patent rights of PIKE Technologies, Inc. nor the rights of others. PIKE Technologies, Inc. does not assume any liability arising out of any infringements of patents or other rights of third parties.

This document contains confidential or proprietary information of PIKE Technologies, Inc. Neither this document nor the information herein is to be reproduced, distributed, used or disclosed, either in whole or in part, except as specifically authorized by PIKE Technologies, Inc.

PIKE Technologies, Inc. makes no warranty of any kind with regard to this material including, but not limited to, the implied warranties of merchantability and fitness for a particular purpose.

Copyright 1991-2010 by PIKE Technologies, Inc., Madison, WI 53719. Printed in the United States of America. All world rights reserved. No part of this publication may be stored in a retrieval system, transmitted, or reproduced in any way, including but not limited to, photocopy, photograph, magnetic or other record, without the prior written permission of PIKE Technologies, Inc. Address Comments to:

PIKE Technologies, Inc.  
6125 Cottonwood Drive  
Madison, WI 53719

Phone (608) 274-2721  
Fax (608) 274-0103  
E-mail [Sales@piketech.com](mailto:Sales@piketech.com)  
Web Site [www.piketech.com](http://www.piketech.com)

**Part Number 350-161190-01**  
Release July 2010

## Evacuatable KBr Die Kit for preparation of high quality pellets, part number 161-1900

Preparation of KBr pellets with a 13-mm die and a hydraulic press is a popular method used for the generation of samples for transmission measurements. It is also required by a number of standardized procedures, including some USLP and ASTM methods. The advantages of this approach are the making of high quality pellets, measurement reproducibility, and the ability to deal with relatively difficult samples.

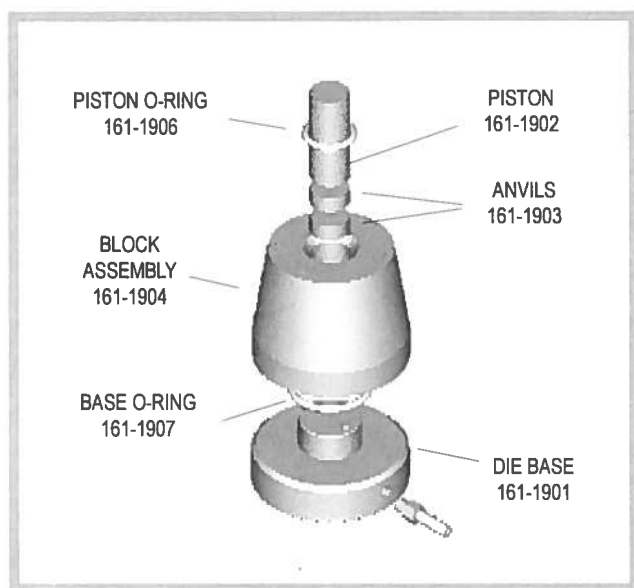

The PIKE Evacuatable KBr Die Kit features the following components: a stainless steel base with vacuum outlet, the main die block with a 13-mm cylinder, two anvils, a plunger, and an ejector ring. Components are made of hardened stainless steel, and surfaces that come in contact with the sample are highly polished. Two different size O-rings are used to seal the base/die assembly and the plunger.

# KIT COMPONENTS

- a. Base
- b. Die Block Assembly
- c. Piston
- d. O-ring
- e. Ejector Ring
- f. Anvils
- g. Base O-ring ( located inside die block assembly)

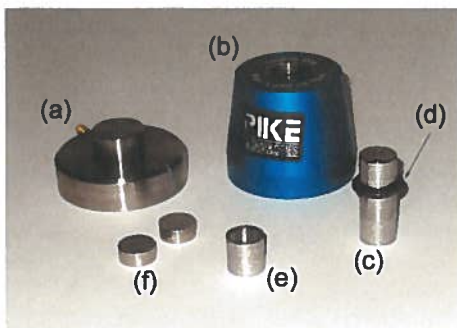

Part no.	Description	
161-1904	Die Block Assembly	1
161-1901	Die Base	1
161-1902	Stainless Steel Piston	1
161-1907	Base O-Ring	1
161-1906	Piston O-ring	2
161-1903	Stainless Steel Anvil	2
161-1908	Ejector Ring	1

## OTHER PIKE PRODUCTS AVAILABLE FOR KBr PELLET PREPARATION

Part no.	Description
181-1100	PIKE CrushIR, Fifteen Ton Digital Hydraulic Press
161-5050	Agate Mortar and Pestle, 50 mm
160-8010	KBr Powder, 100 g
162-5410	Card Pellet Holders (10 pcs)
162-5300	Magnetic Pellet Holder
162-5700	Dual Pellet Holder

# PREPARATION OF 13-mm PELLETS WITH EVACUABLE DIE KIT

## SAMPLE PREPARATION



Use good quality, dry KBr powder (KBr powder should be dried at least once a week in a drying oven at 110 °C overnight). Grind the sample separately using a large mortar and pestle to achieve best results (unless the amount of sample is limited). Start with about 25 mg of sample. Crush and then use circular motion to grind. The sample should achieve glossy appearance when reflecting light. Mix about 10 mg of the sample with 300 mg of the KBr powder - do not grind as this may increase absorption of water by KBr.

### **SAMPLE GRINDING TIPS**

**Use a large mortar and pestle to achieve best results (unless the amount of sample is limited). Start with about 25 mg of sample. Crush and then use circular motion to grind. The sample should achieve glossy appearance when reflecting light. The goal is to reduce particle size to less than the IR wavelength, or to 1-2 micrometers.**

## BOTTOM ANVIL INSERTION

Place one of the anvils in the well of the block assembly. Make sure that the polished surface faces upwards.

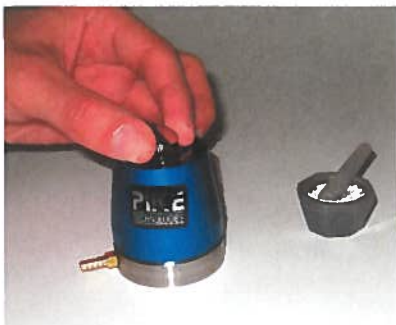

## SAMPLE LOADING

Load sample into the press die. Two scoops (size shown in the picture), approximately 25 mg, produce approximately 0.5 mm thick pellet. Four scoops produce approximately 1 mm thick pellet. Tap the die gently to achieve even sample distribution.



## TOP ANVIL INSERTION

Place the second anvil in the well of the block assembly. Make sure that the polished surface faces downwards.



## PISTON INSERTION



Place piston in the well of the block assembly. The O-ring provides support for the piston and it seals the gap between the piston and the barrel when vacuum is applied.

## CONNECTION OF VACUUM HOSE

Attach a vacuum hose to the barbed fitting in the base.

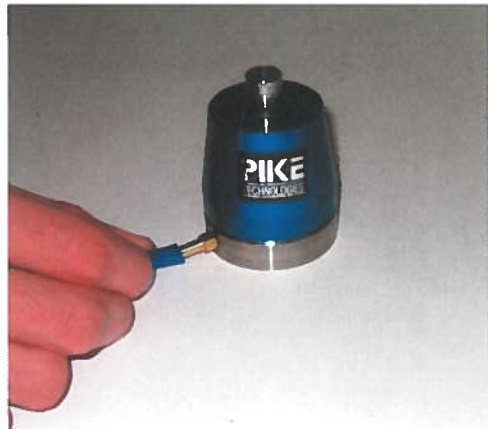

# PELLET PRESSING



Place the die with loaded sample in the pellet press. Attach to the vacuum line and start pulling vacuum to remove moisture, about 1 to 2 minutes. Compress the die to a maximum of 10 tons. Wait for 1 minute minimum; although press time and pellet quality are a function of pellet thickness and applied pressure and time may vary for optimal results. Release the pressure and remove the die from the press.

## PELLET REMOVAL (a)

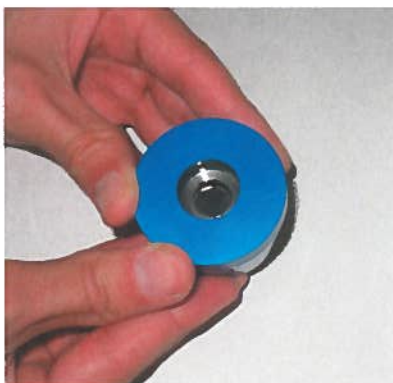

Turn the die upside down and remove the base. Place the piston on a hard surface and press. The pressure should push anvils and the pellet toward you. If hand pressure is insufficient, tap gently with a hard object, until the assembly releases.

**WARNING:** Do not exceed 10 US tons of pressure on the die. Always use safety glasses and follow all safety procedures when working with the KBr Die Kit and high capacity hydraulic presses.



## PELLET REMOVAL (b)



When the bottom anvil emerges sufficiently, remove it gently with your fingers. The pellet, resting on the upper polished anvil, will be exposed at this point. Keep pressing gently at the surface until the second anvil is exposed. If necessary, the ejector ring may be placed underneath to extend the travel of the piston.

## PELLET REMOVAL (c)

With forceps (or gloved hand) gently remove the KBr pellet from the anvil.

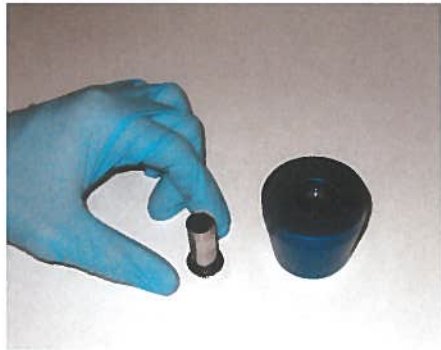

# PELLET MOUNTING

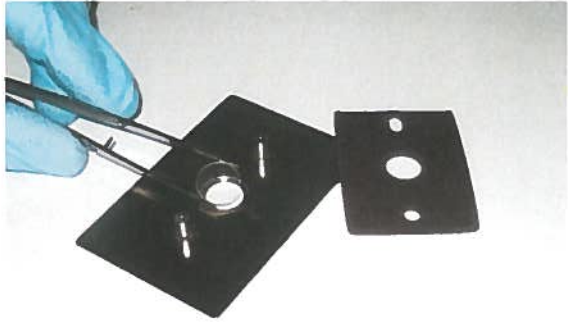

Place the pellet on the 13 mm Magnetic Pellet Holder and secure it with a magnet, or attach it to the adhesive ring of a disposable card. Place in the slide holder of your spectrometer for analysis.

# Caution

The pellet press has a force rating of 10 US tons (9.07 metric tons). Exceeding this force will damage the press.

Do not leave KBr powder in the pellet press for prolonged durations (i.e. overnight) as damage may result from the corrosion/rust of steel anvils and body of the pellet press. This is caused by the acceleration of corrosion/rust in the presences of a salt or acid due to the increased concentration of ions.